

PR-2000

*High Frequency
Inverter
Resistance Spot
Welder*

Instruction Manual



Table Of Contents

Quick start instructions

1 Introduction

2 Safety

2.1 General	.5
2.2 Warnings and important notices	.5
2.3 Safety devices	.7
2.3.1 Cooling	.7
2.3.2 Overheat protection	.7

3 Installation

3.1 General	.8
3.2 Packaging and delivery inspection	.8
3.3 Welder assembly	.8
3.4 Connection of electrical supply	.9
3.4.1 Electrical Plug / Extension cords	.9
3.5 Connection of pneumatic air supply	.9

4 Operation

4.1 Before you begin welding	.10
4.2 About your welder	.11
4.2.1 Technical Specifications	.11
4.2.2 Getting familiar with your welder	.11
4.2.3 PR-2000 Control Panel	.12
4.2.4 Indications on the Control Panel	.12
4.3 Turning on the welder	.12
4.4 Choosing the weld mode	.13
4.5 Setting the pneumatic air pressure	.13
4.6 Setting the weld current	.13
4.7 Setting the weld time	.13
4.8 Setting the default weld programs	.14

5 Double-Sided Welding

5.1 PS-500 Double-Acting Spot Gun	.15
5.1.1 PS-500 Component Diagram	.15
5.1.2 Using the Double-Acting Gun	.15
5.2 Extension Arms	.16
5.2.1 Switching to extension arms	.16
5.2.2 Extension Arms and Welding Electrodes	.17
5.3 PS-500 Electrode Alignment	.18
5.4 Removing Welding Electrodes	.19
5.5 Welding Electrode Maintenance	.20
5.6 Wheel House Arm	.20
5.7 X Adapter (optional)	.21
5.7.1 Attaching the X Adapter	.21
5.7.2 Using the X Adapter	.22
5.7.3 X Adapter Configurations	.22

Table Of Contents

6 Single-Sided Welding

- 6.1 Single-Sided Welding Overview23
- 6.2 Single-Sided Spot Welding24
- 6.3 Pro Pull Dent Pulling (optional)24
 - 6.3.1 Selecting Pro Pull Weld Mode24
 - 6.3.2 Pro Pull Component Diagram25
 - 6.3.3 Pro Pull Assembly25
 - 6.3.4 Dent Pulling with Pro Pull25
 - 6.3.5 Paintless Dent Pulling With Pro Pull26

Quick start instructions



Figure 1.1



Figure 1.2

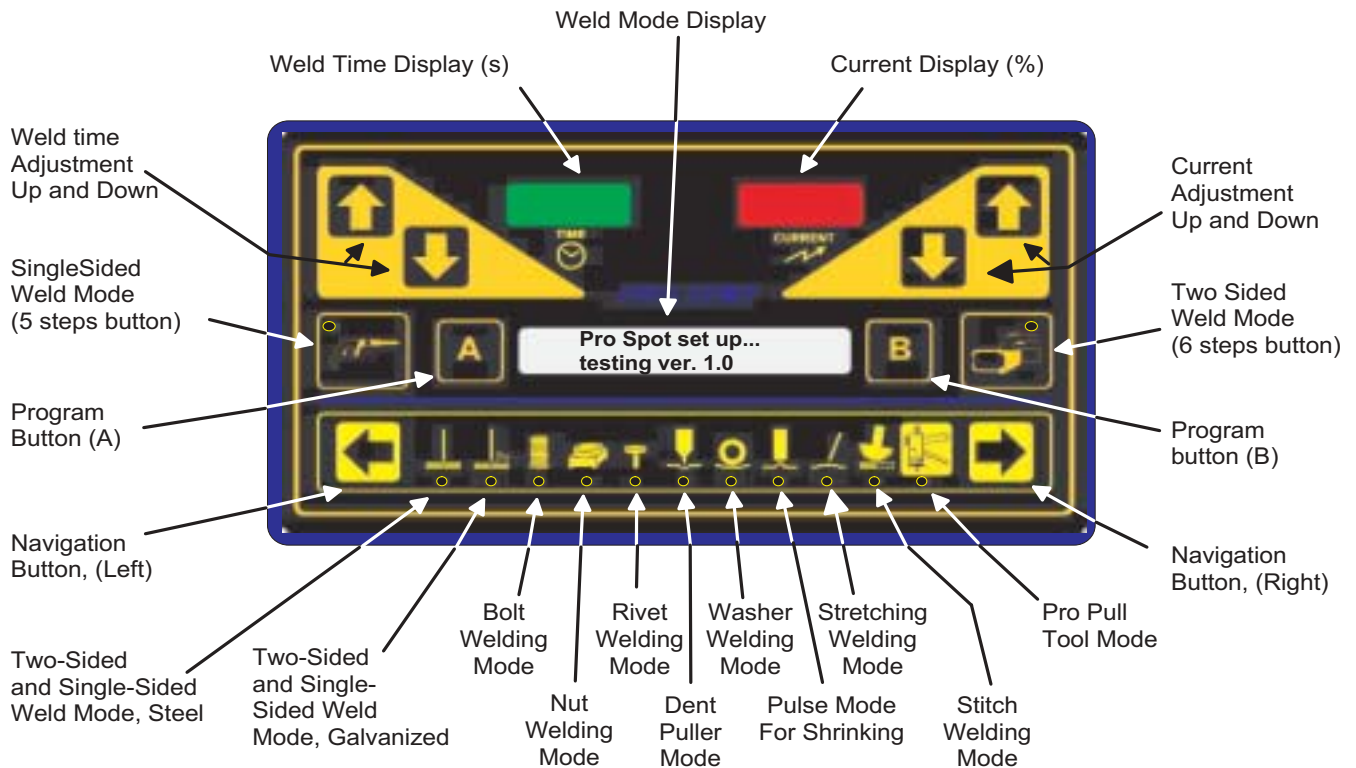

Figure 1.3



Figure 1.4

1. Set Circuit Breaker on the back panel to ON.
2. Turn Power Switch clockwise to ON.
3. Connect Air to the air inlet located on the back panel.
4. After test procedure, select Two-Sided Weld Mode or Single-Sided Weld Mode by pressing the respective push buttons (fig. 1.1)
5. Select desired Power Setting. The CURRENT and TIME settings are displayed in the red and blue window. The thickness to be welded is displayed in the top right corner of the Weld Mode Display. For example, 0.6/0.8mm is the setting to use when welding two sheets of that thickness (fig. 1.2)
6. Press the Weld Mode Button again and the program will move to the next default weld setting (fig. 1.3)
7. There are 5 default settings available for the Two-Sided Weld Mode (0.6/0.8mm, 1.0mm, 1.2mm, 1.5mm, 2.0mm, 2.5mm) and four default settings for Single-Sided Weld Mode (0.6, 0.8mm, 1.0mm, 1.2mm).
8. The top right corner of the Weld Mode Display will show the new metal thickness.
9. You can also change settings manually by pressing the UP and DOWN arrows at any time (fig. 1.4)



1 Introduction

Congratulations on acquiring your new PRO SPOT PR-2000 welder!

Team Pro Spot looks forward to supporting you.

You have a welder and support group that will increase your productivity. The integrated features, ease of use, speed and quality welds that your PR-2000 offers will become an important part of your business.

The following information will be needed when you call Pro Spot:

* MODEL TYPE: PR-2000

* SERIAL NO: _____

The serial number is located on the back of the unit.

For parts or service contact your local distributor,

Local number: _____

or in the U.S. call: Toll free: 1-877 PRO SPOT or 1-760-489-1380

for a customer service representative.

Visit Pro Spot On-Line: www.prospot.com E-mail: info@prospot.com

NOTE: You can now order parts online at: prospot.safeshopper.com

The PR-2000 Spot welder is used by body shops to duplicate the welding procedure used by the car manufacturers. Use of the equipment that is contrary to the instructions in this manual can cause personal injury and/or machine damage.

Pro Spot International, Inc. can in no way be held responsible for intentional or unintentional damage, and consequent unlimited loss of profit, loss of income, loss of business opportunity, loss of use, etc. that originates from incorrect use of this equipment in its use in a manner not intended.

Warranty

Pro Spot International, Inc. offers a two-year guarantee from the date of delivery of the new welder. This guarantee covers material defects and assumes normal care and maintenance.

The guarantee assumes that:

- the equipment is correctly installed and inspected
- the equipment has not been altered or rebuilt without approval from Pro Spot International, Inc.
- genuine Pro Spot International, Inc. spare parts are used to make repairs.
- operation and maintenance has been carried out according to the instructions in this manual.

All claims on warranty must verify that the fault has occurred within the guarantee period, and that the unit has been used within its operating range as stated in the specifications. All claims must include the product type and serial number. This data is stamped on the name plate.

Note: This instruction manual provides advice as well as instructions for installation, operation, maintenance and troubleshooting.



IMPORTANT! Read this manual carefully to become familiar with the proper operation of the welder. Do not neglect to do this as improper handling may result in personal injury and damage to the equipment.

The drawings in this manual are presented for illustrative purposes only and do not necessarily show the design of the equipment available on the market at any given time. The equipment is intended for use in accordance with current trade practice and appropriate safety regulations. The equipment illustrated in the manual may be changed without prior notice.

The contents in this publication can be changed without prior notice.

This publication contains information that is protected by copyright laws. No part of this publication may be reproduced, stored in a system for information retrieval or be transmitted in any form, in any manner, without Pro Spot International, Inc.'s written consent.

Conformity with directives and standards:
PR-2000 complies with CE standards.

2 Safety

2.1 General

The PR-2000 Spot welder has been designed and is tested to meet strict safety requirements. Please read the following instructions carefully before operating the PR-2000 and refer to them as needed to ensure the continued safe operation of the welder

Information provided in this manual describes the suggested best working practices and should in no way take precedence over individual responsibilities or local regulations.

The PR-2000 Spot Welder is designed to comply with all applicable safety regulations for this type of equipment. During operation, it is always each individual's responsibility to consider:

- Their own and other's personal safety.
- The safety of the welder through correct use of the equipment in accordance with the descriptions and instructions provided in this manual.

By observing and following the safety precautions, users of the PR-2000 Spot welder will ensure safer working conditions for themselves and their fellow workers.

2.2 Warnings and important notices

The following types of safety signs are used on the equipment and in Pro Spot's instruction manuals:



Prohibited.

Prohibits behaviour that can cause injury.



Command.

Calls for a specific action.



Warning.

Notice of personal injury risk and or damage to equipment.

The following warnings and important notices are used in the instruction manual:



WARNING! Do not operate or place the welder near water, in wet locations or outdoors. Risk for injuries or damage to the welder.



WARNING! Do not place the welder on unstable or uneven ground. The welder might tip causing personal injuries or serious damage to the welder.



WARNING! All electrical connections must be made by a qualified electrician. Risk for electrical shock.



WARNING! Loose cables and hoses present tripping risks. Risk for injuries.



WARNING! Make sure to use welding goggles when spot welding. The sparks might otherwise injure the eyes.



WARNING! Sparks from welding could start a fire. Risk for injuries.



WARNING! Risk for damage to materials close to the weld, e.g to glass or textiles.



WARNING! For proper cooling efficiency, never operate the welder without connecting it to the compressed air source.



WARNING! All service and maintenance must be carried out by Pro Spot service personnel and service support. Risk for electrical shock.



WARNING! Unplug the welder from the wall outlet before servicing, cleaning or maintenance. Risk for electrical shock.



IMPORTANT! The PR-2000 welder may only be used by qualified personnel. The user of the welder must have knowledge of spot welding and of alignment of collision-damaged vehicles.



IMPORTANT! Do not turn off the welder while cooling is activated!



IMPORTANT! The air must be clean and free from oil and moisture. Use filter.

2.3 Safety devices

When the Spot Gun is used continuously, the welding cables and the power transformer get hot. To prevent the welder from malfunctioning due to overheating, it is continuously cooled during operation.

Note: The Single-Sided Gun and its cables are automatically cooled and are not protected by any overheat protection.

2.3.1 Cooling



Figure 2.1

PR-2000 features an air cooling system that cools all four welding cables. There are two different Cooling Modes: "AUTO" (default) and "ON". In the "AUTO" mode, the cooling system turns on automatically after 15-30 welds and forced air starts to flow through the cable. In the "ON" mode the cooling system operates continuously. To switch to "ON" mode, press "A" and "B" buttons simultaneously on the control panel (fig. 2.1) The display will change to "Cooling Air: ON". To go back to "AUTO", press "A" and "B" again.

2.3.2 Overheat protection

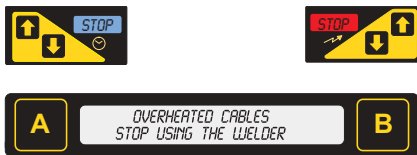

Figure 2.2

The built-in overheat protection is designed to prevent damage to the welder caused by overheating. The system will automatically shut off the welder when a pre-programmed temperature is reached. The Time and Current display will then flash "STOP" (fig. 2.2) and the display will read "Stop using the welder". DO NOT turn off the welder! It needs the cooling air to cool the machine faster. Wait until the "STOP" turns off and the display returns to normal (usually 4-8 min.) Shorter duty cycles (due to short weld times and "rest" periods between welds) will allow the cooling system to function better and may prevent the auto-shut-off. (Consistently check weld strength by performing destructive tests).



IMPORTANT! Do not turn off the welder while the cooling system is activated!



IMPORTANT! If the thermal breaker has switched off the welder, please contact Pro Spot's authorized service personnel

3 Installation

3.1 General

The PR-2000 Spot welder is inspected and tested prior to leaving the factory to guarantee consistent quality and the highest possible reliability. Follow the installation tips and operating instructions below to ensure user safety and proper welder performance.



WARNING! Do not operate or place the welder near water, in wet locations or outdoors. Risk for injuries or damage to the welder.



WARNING! Do not place the welder on unstable or uneven ground. The welder might fall causing personal injuries and damage to the welder.



IMPORTANT! It is the responsibility of the owner to ensure that the equipment has been installed as specified in the instructions provided. It is also the owner's responsibility to ensure that the welder is inspected in accordance with applicable regulations before it is put into service.

A grounded electrical plug must be installed (*refer to section 3.4 "Connection of electrical supply"*).

3.2 Packaging and delivery inspection

Check the contents of the shipping container against the packing list, consignment note, or other delivery documentation to verify that everything is included and in the correct quantity. Check the PR-2000 Spot Welder carefully to make sure that no damage has occurred during transport. If anything is damaged or missing, the welder may be unsafe to use till the part is repaired or replaced. If anything is missing, please contact your supplier. Remove all packaging material from the welder.

3.3 Welder assembly



Figure 3.1

For your convenience, PR-2000 welder ships fully assembled.

Due to differences in wiring codes and connection methods, no electrical plug comes with the welder. Consult a certified electrician for proper installation of the electrical plug.

Insert the support arm (boom) as shown in Figure 3.1

3.4 Connection of electrical supply

The PR-2000 Spot Welder requires one of the following voltage / frequency combinations:

- D 208-240V 50/60 Hz U.S.A., Canada, Japan *OR*
- D 400-420V 50/60 Hz Europe, Australia

Note: Make sure that the facility supply voltage and frequency are the same as shown on the welder name plate (see section 4.2 “About your welder”).

The power supply must have a ground connection. The supply must also be protected as follows:

- D The 208-240V 3-Phase or Single-Phase require 60A breaker.
- D The 400V and 420V supply require a 32A slow blow fuse (Circuit breaker 32D).



WARNING! All electrical connections must be made by a qualified electrician. Risk for electrical shock.

1. Connect the green wire to ground.

Note: Make sure that the supply cable is at least 6 AWG at 208V and 400 V.

3.4.1 Electrical Plug / Extension cords

2. If an extension cord is used with the welder, ensure that the length of the extension cord does not exceed 10 m (30 ft) and it meets the specifications of Item 1 above. The cord must also be grounded. Consult an electrician for safe and proper installation of the electrical plug.

NOTE: When connecting the welder to Single-Phase input power, install Red and White wires. Connect Green to earth ground! **Leave out the black wire.** Insulate and store the black wire properly.

3.5 Connection of pneumatic air supply

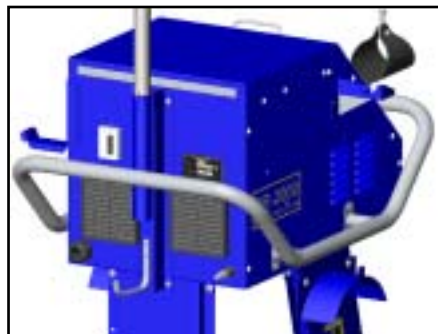

Figure 3.2

Air supply port

The PR-2000 Spot welder must be connected to a pneumatic air network.

1. Connect the PR-2000 to the air supply via the threaded input port at the rear of the welder using a standard connector.
2. If not already set, adjust the air pressure setting on the welder front panel to 60 PSI (4-5 bar) (refer to section 4.5 “Setting the pneumatic air pressure”).



IMPORTANT! The air must be clean and free from oil and moisture. Use a filter.

4 Operation

4.1 Before you begin welding

Before you begin welding, be sure to read and understand the following instructions.

The Pro Spot PR-2000 is a state-of-the-art Inverter Resistance Spot Welder that was designed for the collision repair industry. It duplicates the welding procedure used by the car manufacturers. It is important to understand the design and function of this welder before operating it.

ELECTRICITY ONLY: The PR-2000 uses only electricity to create the welds unlike the MIG welder which uses an arc from a feeding wire to build a weld nugget using inert gas and the feeding wire material.

PRESSURE: The PR-2000 has a built in air cylinder that compresses the Double-Sided Gun's welding tips together automatically when triggered. The compression is an important part of a good resistance weld. The pressure is adjustable from the Control Panel. The optimum welding pressure varies between 60-90 PSI (4-6.5 BAR). 70 PSI seems to be a common starting pressure. As a rule, increase pressure with thicker metals but remember that too much pressure could decrease the resistance of the metal between the electrodes, resulting in poor weld penetration.

CURRENT: Another important aspect of a weld is the current applied through the work piece. A weld is created when a large current is transferred through the layers of sheet metal. The resistance in the metal causes the area to heat up and fuse the sheets together in a nugget.

WELD PROGRAM: Maintaining the air pressure after the current shuts off makes the weld cool down under pressure resulting in a harder, stronger weld. This feature is built in to the PR-2000's weld control program and is engaged automatically during a weld cycle.

TIME: The Timer controls the duration of the current applied during the weld cycle. The ideal is to get a weld that uses higher current and shorter time to control heat buildup.

4.2 About your welder

4.2.1 Technical Specifications

The welder is supplied with one of the following voltage and frequency combinations:

Input voltage: 1 or 3 phase
208-240V 50/60 Hz. OR
400-420V 50/60 Hz.

The actual voltage and frequency is stated on the rear panel name plate.

Note: For 1-phase installation leave out black wire.

Welding amperage: 9500A max (3-phase)
6300A max (1-phase)

Cable length: 8' (2.5m) standard

Electrode Pressure: At 7 bars (90 PSI)-280 DaN (616 Lb)

Cooling system: Air (2 fans)

Welding cable cooling: Air cooling

Microprocessor program: Digital control

Weight (standard): 213lb (97kg)



The name plate is at the rear of the welder unit.
The required voltage is indicated with a check mark.

4.2.2 Getting familiar with your welder

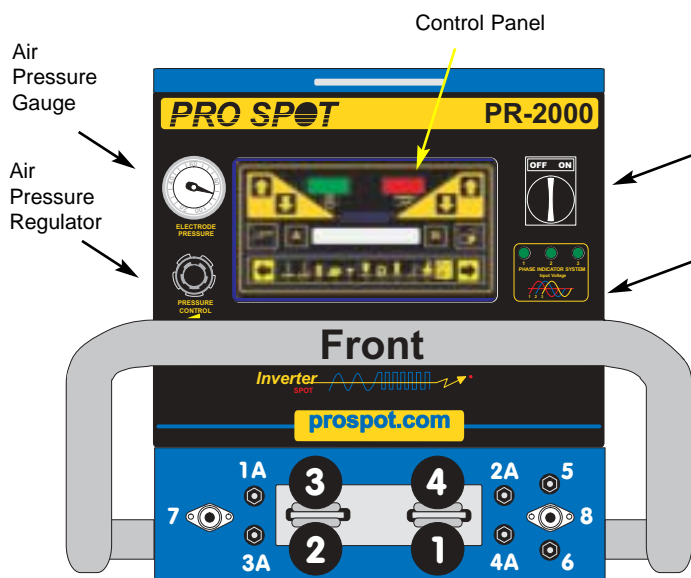

Figure 4.1 PR-2000-Front View

Power Switch:
Turn clockwise to "ON"
Note: Circuit Breaker on the back of the unit must be "ON" first.

Input Voltage Phase Indicator LED Lights should illuminate when circuit breaker on the rear panel is "ON".
(2 lights for 1 phase or 3 lights for 3 phase)

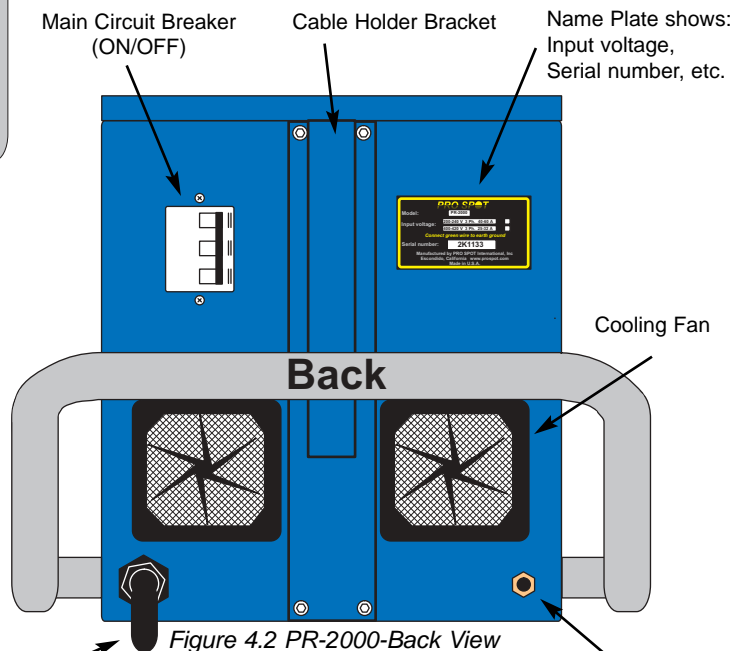

Figure 4.2 PR-2000-Back View

WELD CABLES CONFIGURATION

- ① Single-Sided Weld Gun cable
- ② Single-Sided ground cable
- ③ Two-Sided spot gun cable
- ④ Two-Sided spot gun cable

AIR HOSE CONFIGURATION

- 1A Cooling hose for Single-Sided Weld Gun cable
- 2A Cooling hose for Single-Sided ground cable
- 3A Cooling hose for Two-Sided Gun cable
- 4A Cooling hose for Two-Sided Spot Gun cable

Input Voltage Cable.
Consult certified electrician for installation of proper plug and voltage.

Air Input
Connect filtered air
100 PSI 7 BAR (min)

4.2.3 PR-2000 Control Panel

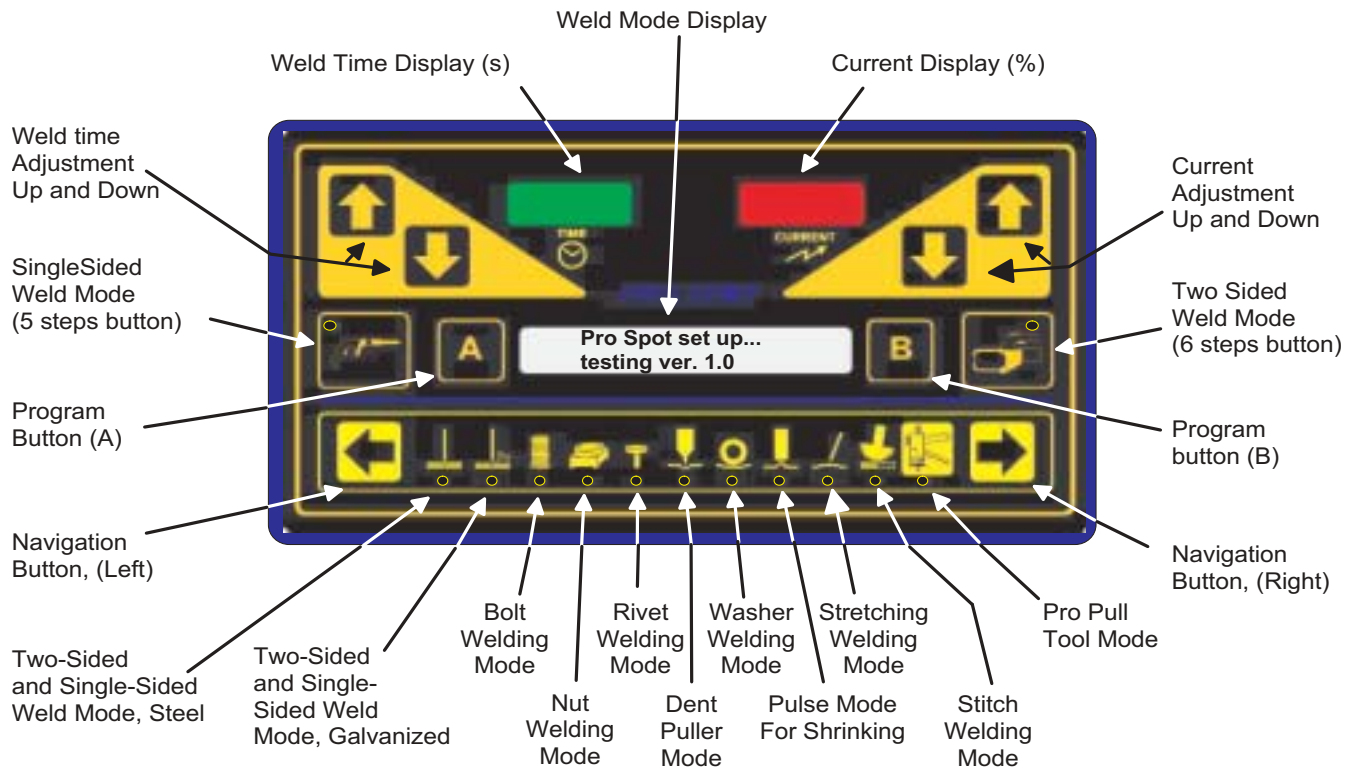
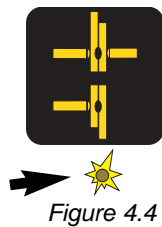

Figure 4.3 The PR-2000 Control Panel

4.2.4 Indications on the Control Panel



The selected weld program is indicated by a lighted LED. As shown in fig. 4.4, the program “Two-Sided Spot Welding” is selected.

4.3 Turning on the welder

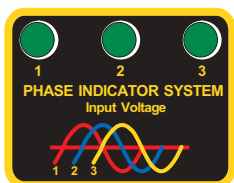

Figure 4.5

1. Toggle the circuit breaker on the back panel to “ON”. Three green lights on the front panel should illuminate indicating 3-phase installation, 2 green lights for 1-phase installation (*fig. 4.5*)
2. Rotate the power switch to the “ON” position. It takes 1-2 seconds for the contactor to close, and the control system to power up.
3. The display will go through the start-up procedure and automatically default to Two-Sided welding.
4. The PR-2000 is now ready to use.



IMPORTANT! Make sure to read the instruction manual before operating the welder. Only trained personell should use this welder.

4.4 Choosing the weld mode



Figure 4.6

The PR-2000 is a multi-functional resistance spot welder. It is equipped with a four weld cable system for your convenience. Two of the weld cables are connected to the Two-Sided Spot Gun and the other two are connected to the Single-Sided Weld Gun.

To select a weld mode, press the respective mode button (fig. 4.6)

Once the welding mode is selected, a group of related weld programs become available to the user (see section 4.8 "Setting the default weld programs")

4.5 Setting the pneumatic air pressure

Pneumatic air is used for:

- forcing the spot gun to close and open.
- cooling the welding cables that are connected to the spot gun.

The air pressure is regulated with the air regulator, and the set pressure is indicated on the pressure gauge. Default pressure is 70 PSI.

Change the air pressure as follows:

1. Unlock the pressure regulator by pulling on the adjustor knob till it snaps into the unlocked position.
2. Turn the pressure regulator knob clockwise to increase or counter-clockwise to decrease the air pressure.
3. Lock the pressure regulator by returning the knob to the lock position.

4.6 Setting the weld current



Figure 4.7

The current regulator circuit controls the amount of the current applied to the material welded. It is best to use a high current and short time to control heat buildup in the body panel.

Set the weld current by pressing the up or down arrows on the control panel

The CURRENT setting is displayed in the red window.

4.7 Setting the weld time



Figure 4.8

The timer circuit controls the duration of the current applied the material welded.

Set the weld time by pressing the up or down arrows on the control panel

The TIME setting is displayed in the blue window.

4.8 Setting the default weld programs

There are 14 weld programs on the PR-2000 Spot Welder. Eleven of these programs are associated with the Single-Sided Gun and the remaining three programs are associated with the Two-Sided Spot Gun.

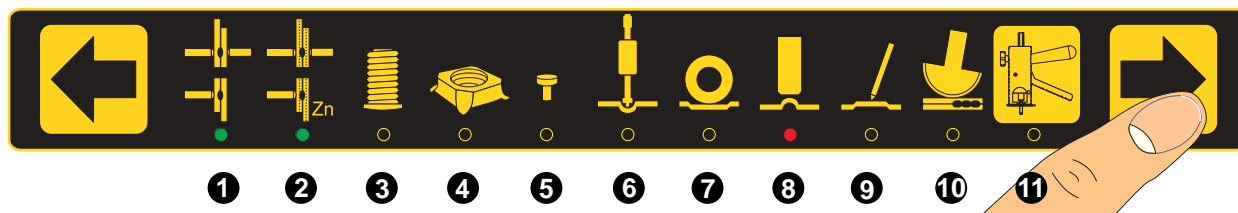

Figure 4.9 PR-2000 Weld Programs

- ❶ Single / Two-Sided spot welding - Mild Steel
- ❷ Single / Two-Sided spot welding - Galvanized Steel
- ❸ Bolt Welding
- ❹ Nut Welding
- ❺ Rivet Welding
- ❻ Dent Pulling
- ❼ Washer Welding
- ❽ Contact Shrinking(Single-Sided Mode) / Pulse Welding(Two-Sided Mode)
- ❾ Carbon Rod Shrinking
- ❿ Stitch Welding
- ⓫ Pro Pull Dent Removal



Note: Two-Sided welding mode and Program No. 1 are set by default when the PR-2000 is turned on.

The welding programs are selected on the Control Panel. Select the welding program by using the Left and Right navigation buttons (*fig. 4.9*)

The selected program is indicated with a lighted LED on the control panel.

5 Double-Sided Welding

5.1 PS-500 Double-Acting Spot Gun

The spot gun is used for the following weld programs:

- Two-Sided spot welding
- Two-Sided spot welding - Galvanized steel
- Pulse welding

(see section 4.8 "Setting the default welding programs")

5.1.1 PS-500 Component Diagram

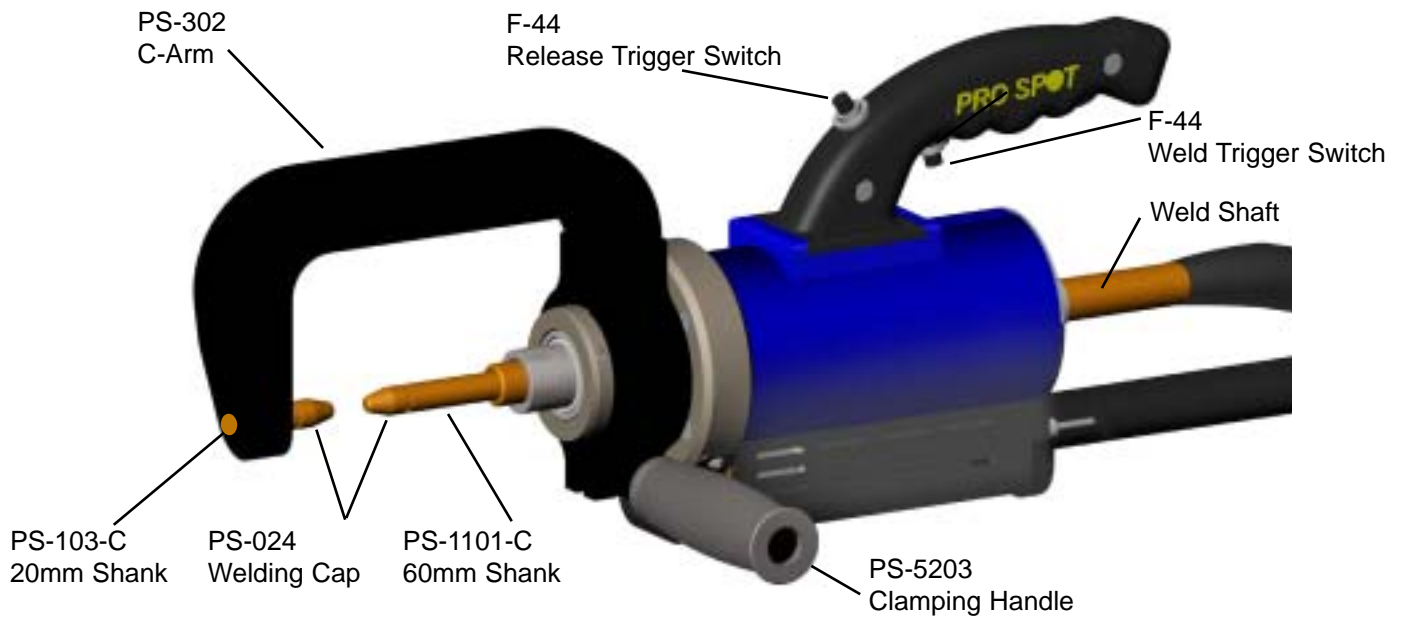

Figure 5.1 PS-500 Spot Gun - Component Diagram

5.1.2 Using the Double-Acting Gun



Push this button to open electrodes wide.

Push this button to close electrodes and weld.

5.2 Extension Arms

The Pro Spot PR-2000 comes with a variety of extension arms to accommodate any welding job situation.

Please refer to *fig. 5.3* for details on what welding electrodes to use with each extension arm.



NOTE: Extension arms marked “*optional*” are available from your local distributor or online at www.prospot.com



Figure 5.2 PR-2000 Extension Arms

5.2.1 Switching to extension arms



5.2.2 Extension Arms and Welding Electrodes

Different extension arms require the use of different welding electrodes. Use charts in *fig. 5.3 and 5.4* to determine the correct combination of extension arms and welding electrodes.



IMPORTANT! Using incorrect welding electrodes with extension arms may result in weak welds and/or damage to your welder.

	A	B	C
	PS-302	PS-1101-C	PS-103
	PS-52	PS-1101-C	PS-1133
	PS-403	PS-128-C	PS-1133
	PS-303	PS-1101-C	PS-103-C
	PS-503-W	PS-128-C	PS-130-C

Figure 5.3 Extension arm - Welding electrode configuration chart





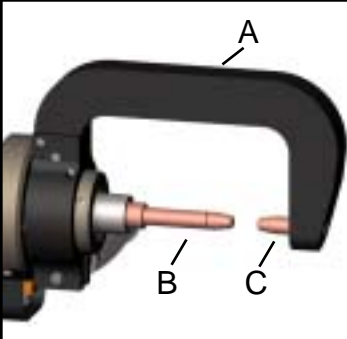

	Electrode Shank	PS-024: Welding Cap
	← 20 mm →	← 20 mm →
	← 40 mm →	
	← 60 mm →	
	← 80 mm →	
	← 100 mm →	
	← 120 mm →	

Figure 5.4 Welding electrode selection chart



NOTE: PS-024 Welding Caps can be purchased in packages of 15 from your local distributor or online at www.prospot.com

5.3 PS-500 Electrode Alignment

Use the set screws (A, B, C) to align the electrodes. Ex: to move electrode down, loosen screw (C) and tighten screws (A and B).

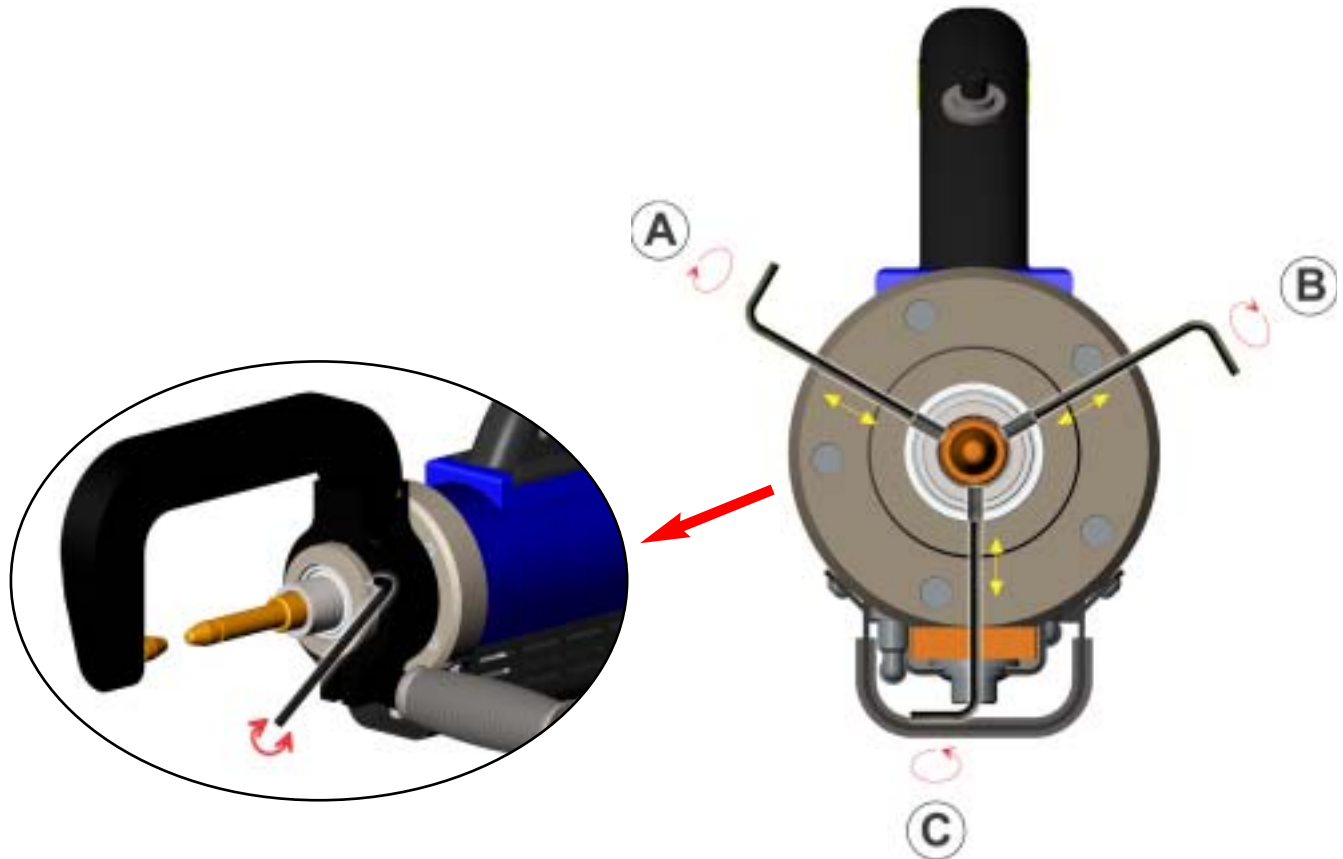
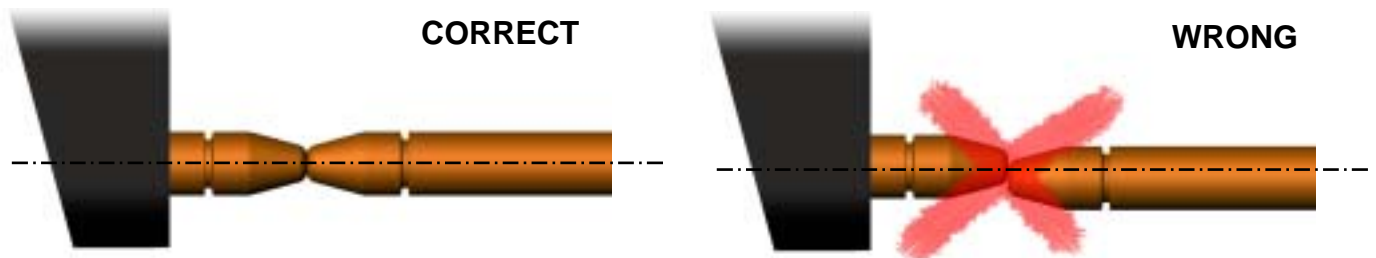

Figure 5.5



IMPORTANT! Always maintain proper electrode alignment. Not doing so may result in weak, substandard welds!

5.4 Removing Welding Electrodes

Removing Extension Arm Electrode

The extension arm electrodes can be easily removed by lightly tapping them with a pin and hammer as shown in *fig. 5.6*

Removing Piston Electrode

To remove the piston electrode:

1. Grip piston electrode with a set of pliers.
2. Rock the pliers back and forth to loosen the electrode from the holder.
3. Remove the electrode



IMPORTANT! Do not attempt to remove the electrode by hitting it. This could damage the electrode and the spot gun.

Removing Welding Cap

To remove a welding cap:

1. Hold piston electrode with a set of pliers.
2. Grip welding cap with another set of pliers.
3. Twist the two to loosen and remove the welding cap.



NOTE: An optional welding electrode cap removal tool is available from your local distributor or online at: www.prospot.com

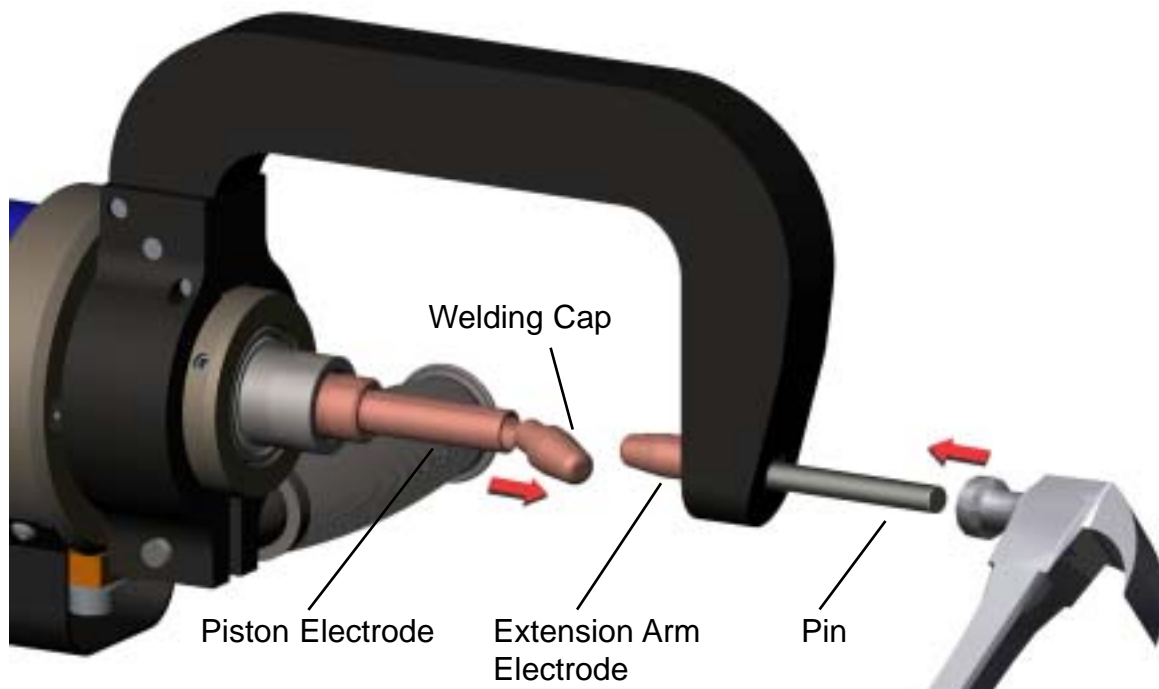

Figure 5.6 Removing Welding Electrodes

5.5 Welding Electrode Maintenance

To maintain structurally-sound welds it is important to keep your welding electrodes clear from build-up. It is also important to maintain a 6mm weld nugget diameter. Clean electrodes with a file and periodically replace welding caps as explained in Section 5.4 "Removing Welding Electrodes"



WARNING! The electrodes may be hot. Use caution when handling them.

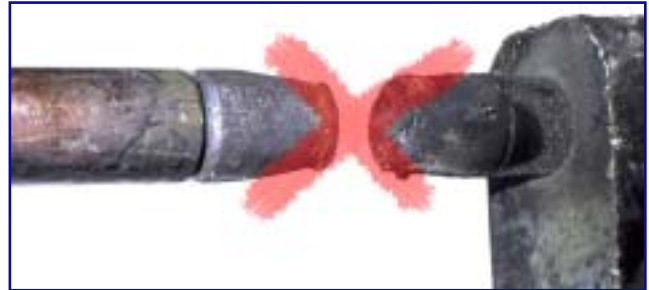
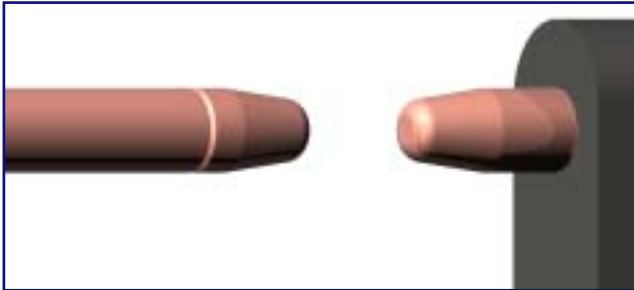

5.6 Wheel House Arm

The wheel house adapter allows access to hard to reach areas such as the wheel house

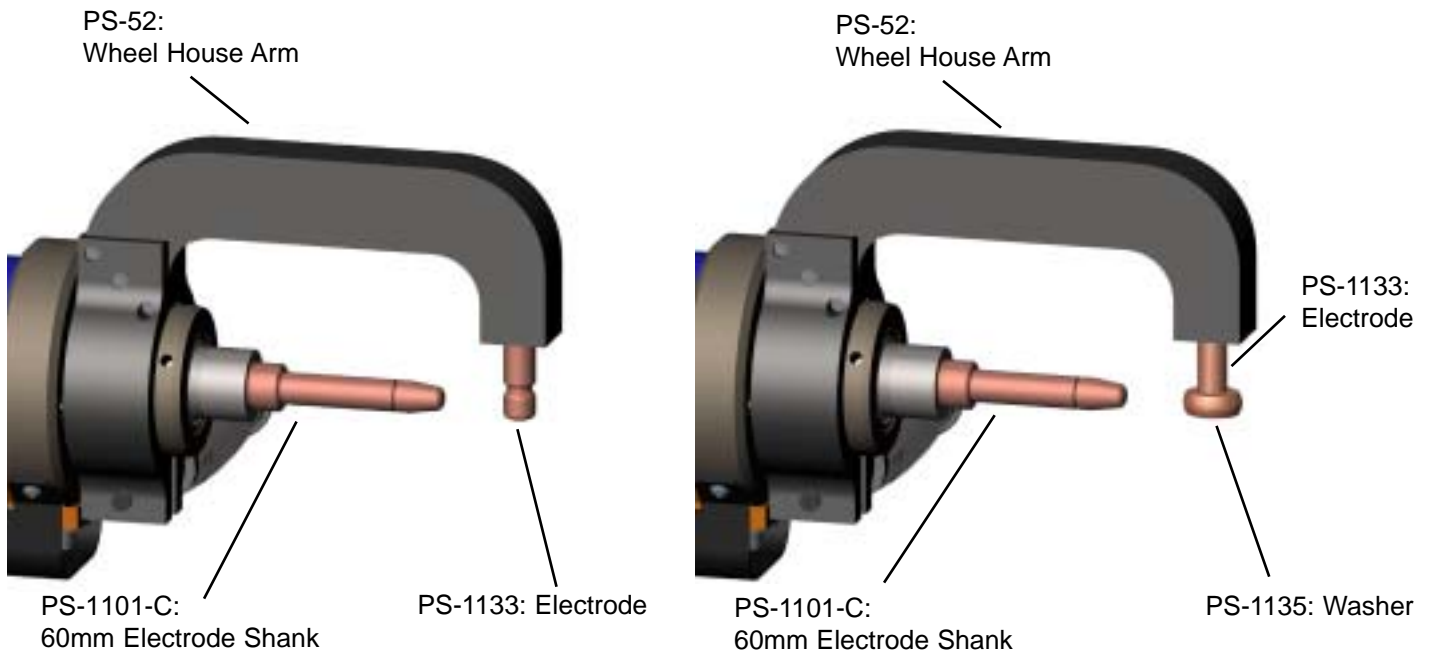

5.7 X-Adapter (optional)



C-TYPE GUN

The advantage of the C-Type Spot Gun is that when making vertical pinch welds on quarter panels, rocker panels, door pillars, etc., the spot gun is positioned perpendicular to the work area. Easy to reach! Easy to use!



X-TYPE GUN

The X-type design is used on certain applications where the C-type can't reach. 90% of all welding needs can be done with the C-type but for some radiator support and truck bed pinch welds, the X-Adapter works better. This new invention from Pro Spot makes it possible to weld where you never could before!

5.7.1 Attaching the X-Adapter



1
Loosen the handle and pull out C-arm...



2
Follow instructions in **Sec. 5.4** to remove piston electrode

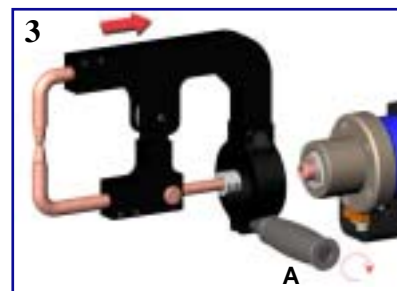

3
Insert the X-Adapter onto the gun. Tighten handle (A).

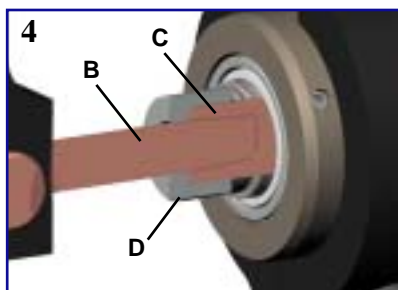

4
Insert the Tapered Electrode (B) into the Shaft (C). Apply air (carefully) to put pressure on the electrodes so that Tapered Electrode seats firmly in the shaft before tightening the Collar (D) set screw.

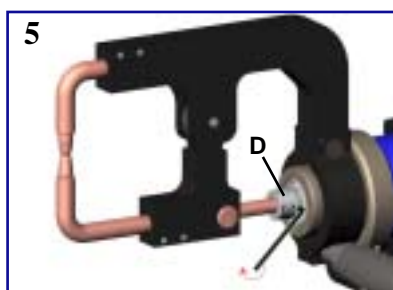

5
Tighten the Collar (D) set screw.



IMPORTANT! Do not tighten the Collar before the inserting Tapered Electrode into the shaft. The collar is designed to prevent the Tapered Electrode from falling out of the Shaft when the gun is fully opened.

5.7 X-Adapter (optional) cont.

5.7.2 Using the X-Adapter



Push the upper switch to open electrodes wide.



Push the lower switch to close electrodes and weld.

5.7.3 X-Adapter Configurations

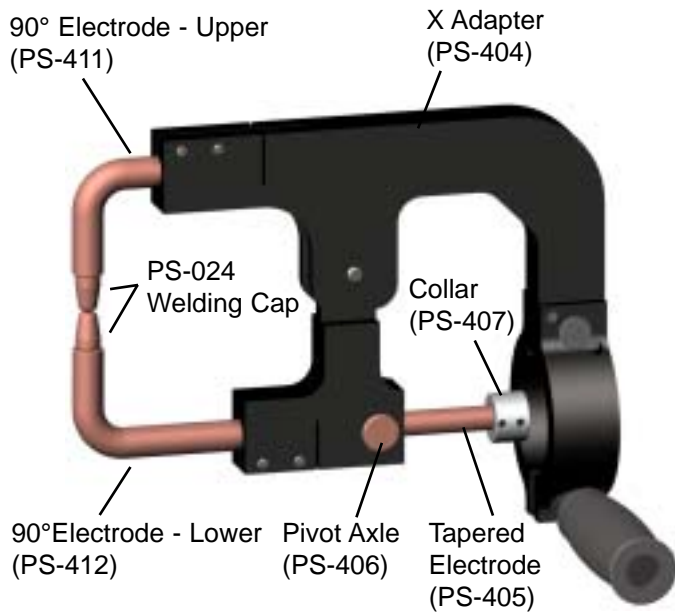

Figure 5.7 90° Arm Set

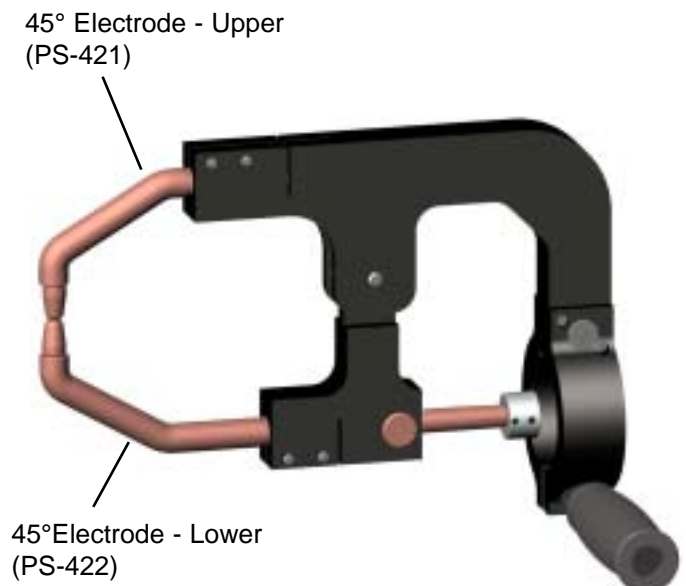

Figure 5.8 45° Arm Set

6 Single-Sided Welding

6.1 Single-Sided Welding Overview



Figure 6.1

The Single-Sided Weld System allows the operator to carry out welding tasks using a Single-Sided Weld Gun. The Single-Sided weld procedure requires contact only from one side compared to two sides in Two-Sided welding. A ground plate must be connected to the panel to be welded for it to work.

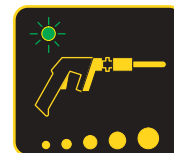

Make sure the ground plate is clamped firmly in place on the inside of a clean metal surface as near as possible to the weld location.

NOTE: Do not attach the ground to the metal you're about to weld on. When performing other weld tasks such as dent pulling, etc., the ground attachment location becomes less critical.

In the Single-Sided weld mode the following weld procedures are available for the PR-2000:

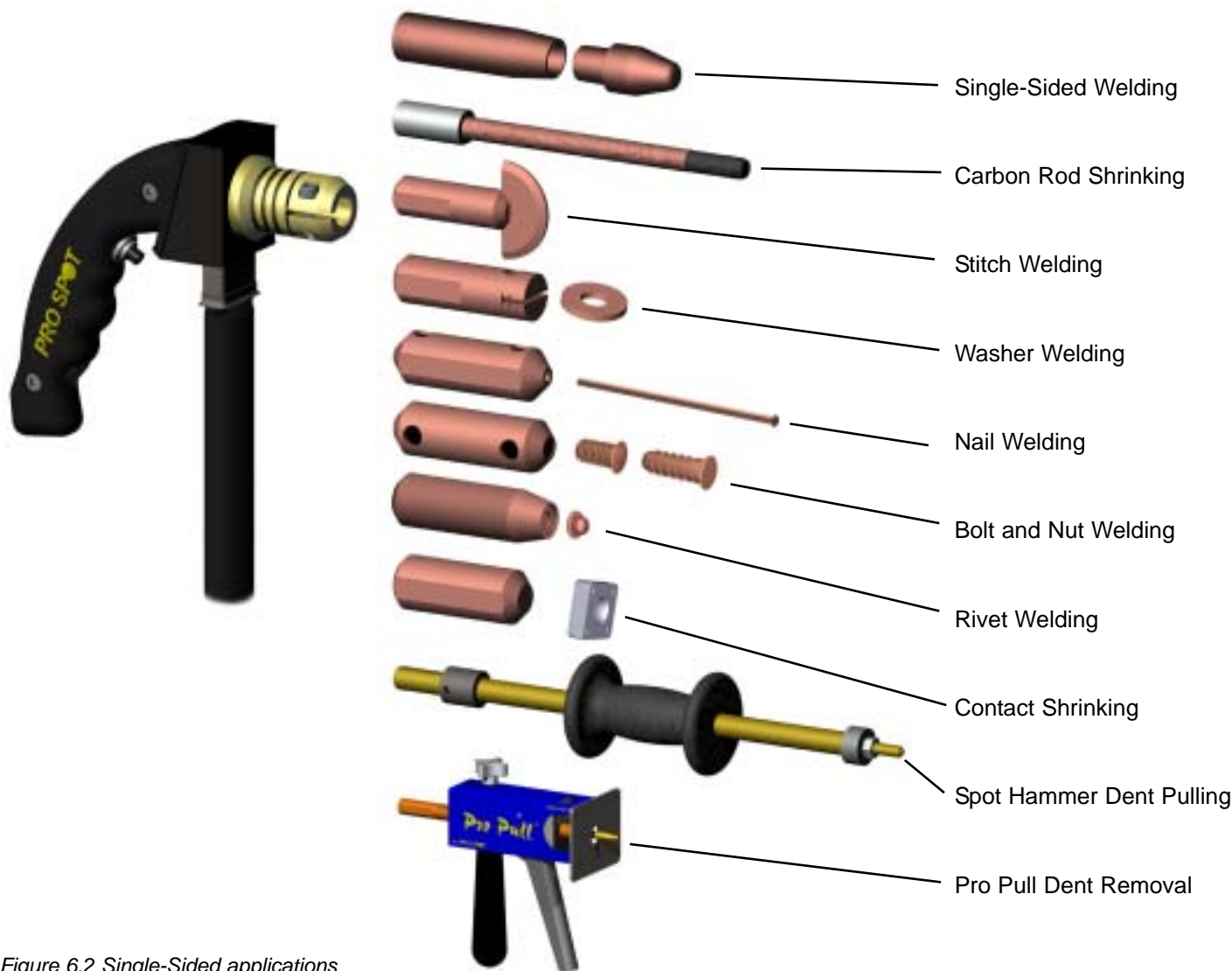

Figure 6.2 Single-Sided applications

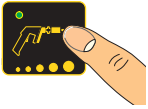

Figure 6.3 Selecting Single -Sided weld mode

SINGLE SIDED WELD MODE

Figure 6.4

1. Make sure the welder is turned on. Push the Single-Sided weld mode button (fig 6.3). The green light will light up when engaged.
2. Use the navigation buttons, Left or Right to select desired weld program (refer to section 4.8 "Setting the default weld program"). The display text shows the currently selected program (fig. 6.4)
3. All modes shown in fig. 6.2 are available in Single-Sided mode except for PRO PULL which is activated by pushing on the PRO PULL Button.

6.2 Single-Sided Spot Welding

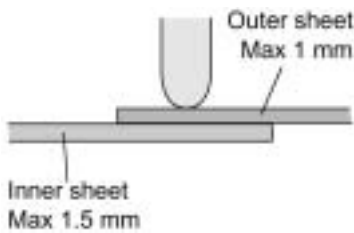

Figure 6.5



Single-Sided spot welding is used where Two-Sided spot welding cannot be used.



Note: The Single-Sided spot welding is not permitted on supporting frameworks of a vehicle. It is only permitted for cosmetic purposes.

1. Set the "Single spot" program on the control panel, refer to section 4.8 "Setting the default weld programs". Make sure that the LED indicates: "Single spot".
2. Set the weld current by pressing the Up or Down arrows on the Control Panel (refer to section 4.6 "Setting the weld current").

6.3 Pro Pull Dent Pulling (optional)

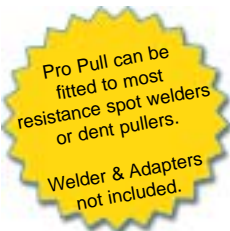

Pro Pull is a patented, innovative tool for fast and accurate dent pulling. It features paintless dent removal functionality (see sec. 6.3.5 "Paintless Dent Pulling With Pro Pull").

6.3.1 Selecting Pro Pull Weld Mode

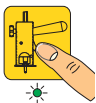

Figure 6.6 Selecting Pro Pull weld mode

1. Make sure the welder is turned on. Press the Pro Pull weld mode button (fig 6.6) The green light will light up when engaged.



Make sure the ground plate is clamped firmly in place on the inside of a clean metal surface as near as possible to the weld location.

NOTE: Do not attach the ground to the metal you're about to weld on. When performing other weld tasks such as dent pulling, etc., the ground attachment location becomes less critical.

6.3 Pro Pull Dent Pulling (optional) cont.

6.3.2 Pro Pull Component Diagram

Pro Pull comes with three different Blocking Plates with Quick-Connect design.

Block window size:
2.5" (63mm) x 1.5" (38mm)

PP-10-04



Large openings for great visual control of the pulling area.

Block window size:
1.75" (44mm) x 1" (25mm)

PP-10-03



Block window size:
0.75" (19mm) dia.

PP-10-01



Clamping knob for quick adjustment of electrode position which allows more accurate dent repair.

PP-06

Retrofit point for different end adapters. Available for most weld guns. (not included) See prospot.com for more information.

CLT-55
Electrode

N-38
Nut

CLP-75

Removable weld shaft. The weld current is transferred through the shaft and NO CABLE is required to transfer the current

6.3.3 Pro Pull Assembly

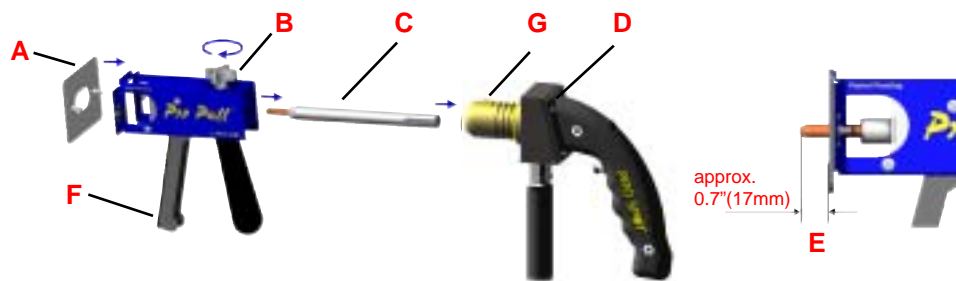

1. Attach the Weld Gun (D) to Weld Shaft (C). Secure Lock Bolt (G).
2. Slide weld shaft and gun to standard distance (E).
3. Attach desired block plate (A)
4. Tighten knob (B).
5. Position the weld tip in the "bottom" of the dent, weld, then pull the handle (F) to initiate the pulling action. Use the shortest weld TIME possible to prevent extensive weld marks.

6.3.4 Dent Pulling with Pro Pull



1. Aim, position & fire!

2. Pull dent with Auto Blocking.

3. Twist gun to release tip.

6.3 Pro Pull Dent Pulling (optional) cont.

6.3.5 Paintless Dent Pulling With Pro Pull

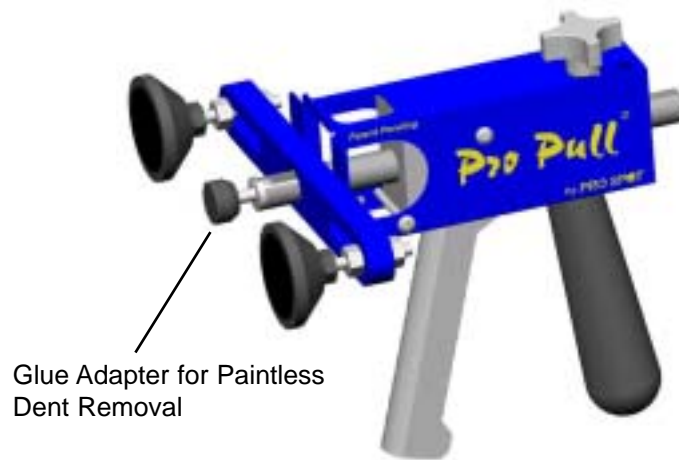

Glue Adapter for Paintless
Dent Removal

Pro Spot PR-2000 comes with below listed parts except for parts listed "Optional"

COMPONENT LIST

PR-2000



SHIPPING DATA:
 Dimensions: 40"x30"x55"
 Weight (unit only): 250 lb.
 Weight (w/crate): 370 lb.



Serial # _____ Checked by: _____

Lid Decal Instruction Manual

PS-500 Pneumatic Spot Gun Complete

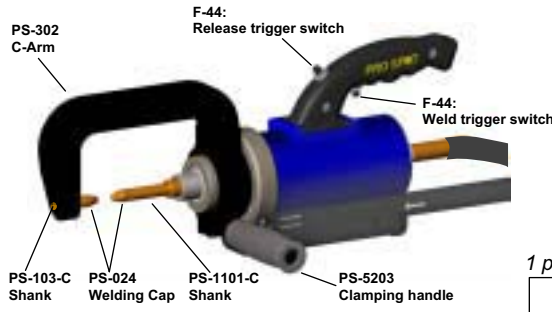

Electrode Reference Chart

Electrode Shank	PS-024: Welding Cap
PS-103-C	20 mm
PS-102-C	40 mm
PS-1101-C	60 mm
PS-128-C	80 mm
PS-129-C	100 mm
PS-130-C	120 mm

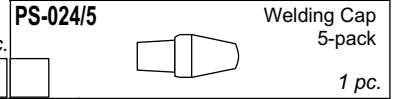

PS-303

- 1ea. Extension arm, 330mm
- 1ea. PS-103-C shank
- 1ea. PS-024 cap

PS-503-W

Extension arm, 600mm
 Use with PS-128-C and PS-130-C electrodes



OPTIONAL PS-024/15 PS-024/15 WELDING CAP REFILL PACK 15 pc.

Note: Refill packs are only available in Qty. of 15

PRO-66 Pro Pull Dent Removal System

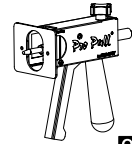

PS-52

Wheel house arm

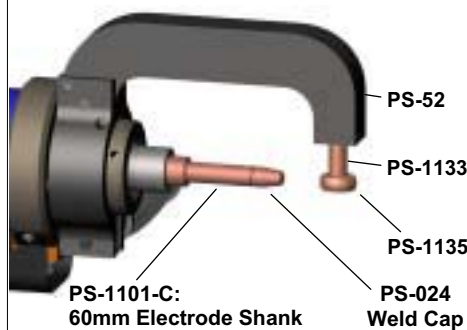
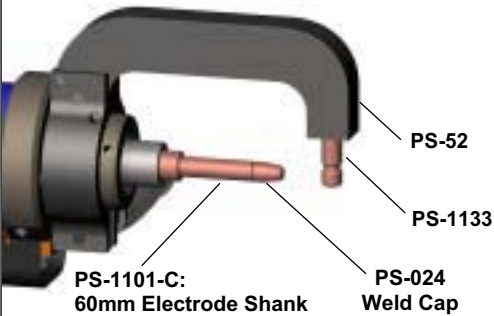

- PS-52
- PS-1133
- PS-1135

PS-3201-3: Single-Sided Gun Assembly:

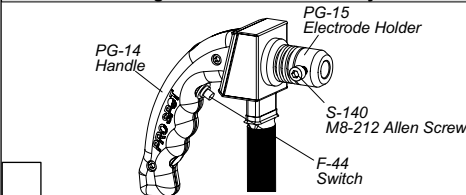

PS-1200



CLP-70

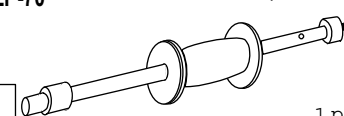

Spot hammer

Allen wrenches

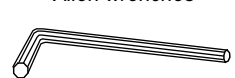

CLT-33

Stitch electrode

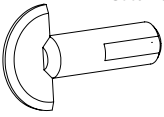

CLT-29

Carbon electrode

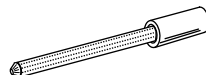

CLT-31-C

Single Sided Weld Electrode

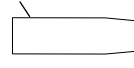

PS-024

Welding Cap

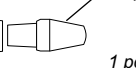

PS-005

Weld Cable Saddle

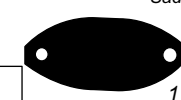

- CLT-57: 3 mm
- CLT-58: 4 mm
- CLT-58A: 5 mm
- CLT-59: 6 mm

PS-840

Washer adapter

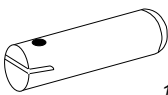

PS-820

Nail and 4mm Stud electrode holder

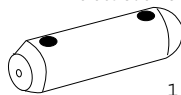

PS-860

Contact shrinking electrode

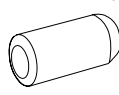

PS-800

Moulding clip rivet holder

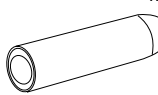

PS-830

Stud electrode holder 5mm / 6mm

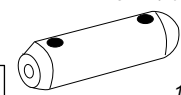

CLT-53-8

Contact tip Spot hammer



CLT-44

Weld on nut 6mm



PS-1201

Weld on bolt M5x12 course



PS-1202

Weld on bolt M6x12



PS-230

Weld on bolt M5x18 course



PS-1204

Moulding clip rivet



CLT-47

Washer



PS-210

Nail 2.5x50mm





Pro Spot international, Inc.
926 S. Andreasen Dr. #101
Escondido, CA 92029

Toll Free: (877) PRO SPOT
Phone: (760) 489-1380
Fax: (760) 489-1531

E-mail: info@prospot.com
Web: www.prospot.com